



PRODUCT

GAPID WS

Product code GAPID WS

GAPID WS



**ANTI-CLIMB TRIAXIAL ACCELEROMETER
SENSOR**

INSTALLATION AND MOUNTING MANUAL VERSION 2.3

Table of contents

1. Introduction.....	3
2. Product description.....	3
3. General warnings.....	4
3.1 Additional warnings for devices powered by mains voltage	
3.2 Installation warnings	
4. List of main components	5
5. Preparation for installation	6
5.1 Preparing the components before installation	
5.2 It is advisable to carry out	
6. Sensor mounting	7
7. Circuit board.....	8
8. Component description	9
9. Description of the functions	11
9.1 Lightweight mesh panels	
9.2 Rigid mesh panels	
9.3 Non-welded chain link fencing	
9.4 Rigid/welded mesh fencing	
9.5 Anti-intrusion walls/railings	
9.6 Windows and indoor applications	
9.7 Self-learning for alarm	
9.8 Self-learning for disqualification	
9.9 Self-learning for spontaneous vibration	
9.10 Reset	
10. Calibration.....	15
10.1 Calibration with self-learning functions	
10.2 Self-learning function for alarm	
10.3 Self-learning function for disqualification	
10.4 Self-learning function for spontaneous vibration	
11. Technical specifications.....	17
12. Product disposal.....	18

1.Introduction

Congratulations on having purchased the Politec anti-climb triaxial accelerometer sensor.This appliance guarantees long-lasting and reliable operation if installed correctly.For correct and effective use, it is necessary to read this instruction manual carefully.



The system has been designed to detect intrusions and activate the alarm; it is not a device that prevents intrusion.Politec is not responsible for damage, injury or loss caused by accidents, theft, force majeure (including momentary lightning-induced overcurrent), abuse, improper or incorrect use, faulty installation or inadequate maintenance.

2. Product description

GAPID is a MEMS sensor that exploits the capabilities of a triaxial accelerometer able to discriminate and/or detect any type of vibration or movement, optimally protecting numerous application surfaces.With 6 preset functions and 3 self-learning functions, cover anti-removal tamper, IP66 shockproof container and battery power supply, GAPID represents the most advanced solution and innovation in the perimeter protection field.

This system is ideal for the perimeter protection of fencing where there is no electricity connection.

Gapid is made up of a solid rear steel plate and a resistant polycarbonate body, all supplied with screws.Gapid is completely waterproof and is suitable for all outdoor environments:

- Mesh and fencing
- Grilles and grating
- Gates
- Railings
- Anti-intrusion walls
- Windows - Indoor
- Garages and doors



Warnings

Mounting, installation of the sensor and connection to the control unit must be carried out by expert and qualified personnel, in compliance with rules and regulations applicable to electrical systems.

3.General warnings

This installation manual contains important information regarding safety for installation: it is necessary to read all the instructions before proceeding with the installation.

Keep this manual for future use.

- If you have any questions or doubts during installation, do not carry out any operations and contact the support service.
- Use of these products for purposes other than those specified in these instructions is prohibited.
- You must not make any change to the components of the product unless stated in the manual in order not to void the warranty; such operations can only lead to malfunctions; Politec assumes no liability for malfunctions or damage due to modified products.
- Depending on the specific situation of use, check for the need for additional devices: detectors or signalling devices.
- During installation, mounting and use of the product, make sure no foreign objects (solids, metals or liquids) are able to penetrate inside the open devices.
- Manufacturer's liability:Politec assumes no liability for failures resulting from incorrect installation; lack of maintenance, incorrect assembly or use.
- Politec is also not liable for incorrect or incomplete operation of the product or failure to detect intrusion.
- Warranty (summary of conditions):Politec guarantees its products for a period of 2 years from the production date.The warranty is applied to those purchasing directly from Politec; there is no warranty for the end user who, in the event of breakdowns or faults, must contact the installer or dealer.
- The warranty excludes aesthetic parts as well as parts subject to normal wear and parts subject to normal consumption such as batteries and accumulators.

3.1 Additional warnings for devices powered by mains voltage

This manual is intended only for technical personnel qualified to install such devices.

- Assessing the hazards that may occur during installation and use of the system, in order to achieve complete safety, it is necessary that installation takes place in full compliance with applicable laws, methods, rules and regulations.
- Before accessing the internal terminals of the product, it is necessary to disconnect all the power circuits.
- If automatic circuit breakers or fuses trip, before resetting them it is necessary to identify the fault and repair it.

3.2 Installation warnings

- Check that all the material to be used is in excellent condition and suitable for use.
- Before proceeding with the installation, check the environmental class of the products in the "technical specifications" chapter.
- Check, by comparing with the values shown in the paragraph "technical specifications".
- Do not place the system components close to heat sources as they could be damaged.
- Each product has its own operating principle: check the instructions for choosing the right position in the respective instruction manual.



4.List of main components

The box contains the following components and accessories.

When opening the package, check that everything has been included.

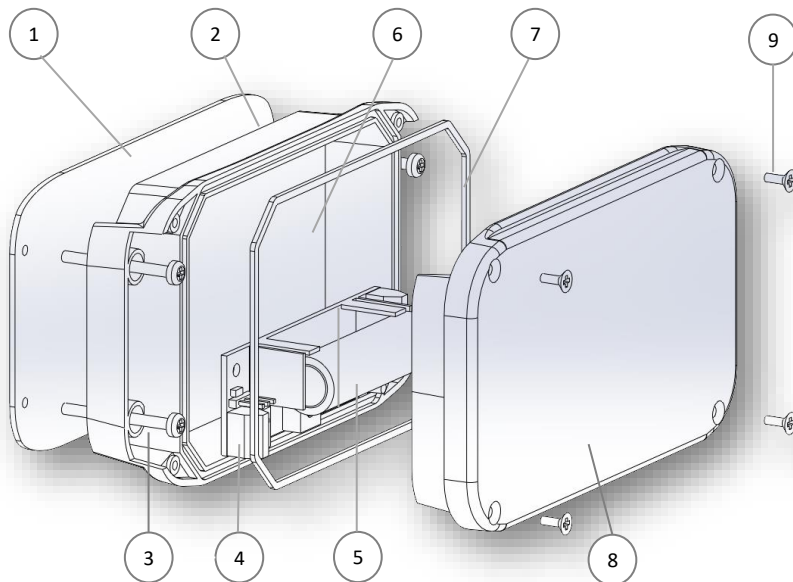

No.	COMPONENT
1	Fixing plate
2	Base
3	Fixing screws
4	Circuit board
5	Battery 3.6 V 2.7 Ah
6	Compartment for radio TX board
7	Protection gasket
8	Cover
9	Closing screws

5.Preparation for installation

5.1 Preparing the components before installation

Since the communication between the sensors takes place through correct installation, it is advisable to firstly check that all sensor components and any accessories are present before beginning the installation.

5.2 It is advisable to carry out:

- the installation of the sensors on the perimeters to be protected;
- checking the functioning of the sensor programs
- the permanent fixing of each sensor;
- the preparation and carrying out of the connections of the radio transmission board with the control unit (check that it is housed inside without problems).

In order to avoid errors, operating and installation problems, it is advisable to proceed as follows:

- a) Place all the products with the package open on a table;
- b) Test the functioning of the sensors;
- c) Arrange (without fixing) the sensors in the planned points;
- d) Check that each sensor responds from the application;
- e) Permanently fix the sensors.

Before proceeding with the installation, it is necessary to check the integrity of the product, the adequacy of the model chosen and the suitability of the environment intended for installation:

- Check that all conditions of use fall within the "limits of use" and in the "Technical specifications of the product".
- Check that the environment chosen for the installation is compatible with the total footprint of the product.
- Check that the surface chosen for the installation of the product is sturdy so as to ensure stable fixing and that it is adequately protected against possible impacts or the elements.



6.Sensor mounting

Placement and installation height

This type of sensor has the optimal sensitivity of a diameter of 5 metres on all types of fences, metal structures and gates. If the fence is supported by poles about 5 metres apart, position the sensor in the centre of this distance, so as to place one in each "sector".

However, it is necessary to take into consideration the type of material of the fence since, depending on whether it is loose mesh, welded or with panels, the material will transmit a different sensitivity.

Position the Gapid in the centre of the panel or the mesh and screw it to the fixing plate positioned on the other side. Tighten the screws firmly to prevent the device from moving.

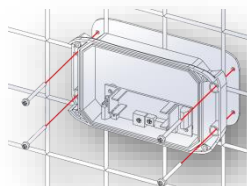

When calibrated and wired with the radio transmitter, power the sensor with the battery, paying attention to its polarity.

Insert the gasket making it adhere to the sensor keeping it well stretched and making sure that it does not twist.

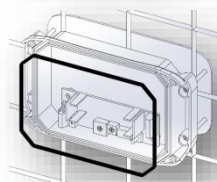

Secure the radio transmitter with the tower adhesive supplied or with the velcro.

N.B.: in case of fixing with towers, place the neoprene strip under the transmitter, in order to avoid that the board vibrates and generates disturbances to the sensor.

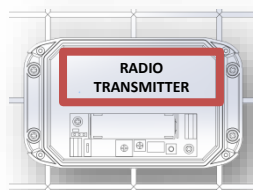

Close the device making sure that the O-ring is well positioned inside the appropriate compartment and that the protective cover closes well.

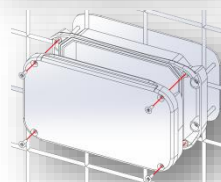

WARNING:

Product warranty is invalid if there is any hole in the product or any component



7.Circuit board

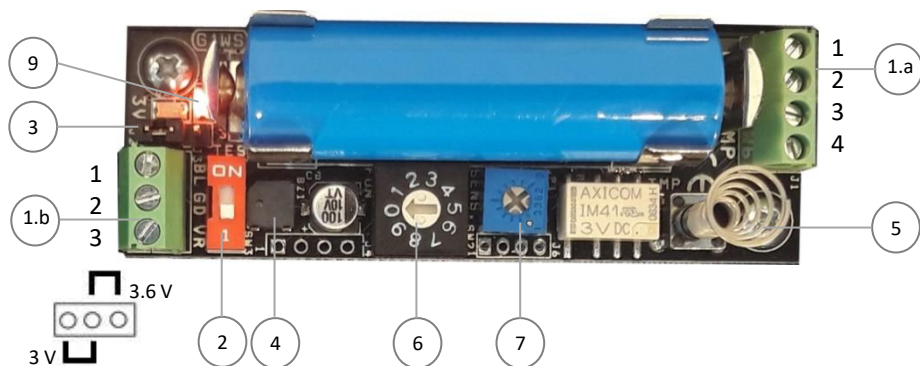

1.a	TERMINAL BOARD	1	ALM	Alarm balance output
		2		
		3	TMP	Tamper balance output
		4		
1.b	TERMINAL BOARD 2	1	BL	Low battery output - negative open collector
		2	GD	Power supply negative
		3	+VR	Radio transmitter power supply <i>OUTPUT</i>
2	TEST DIP			
3	TX RADIO POWER SELECTOR			
4	BUZZER			
5	ANTI-OPENING TAMPER			
6	FUNCTION SELECTOR			
7	SENSITIVITY ADJUSTMENT TRIMMER			
8	BATTERY 3.6 V 2.7 Ah			
9	LED INDICATORS			

8.Component description

1.TERMINAL BOARD:

Tamper and alarm outputs with NC free contacts, with the possibility of balancing on the terminal board.

2.TEST DIP

Set to ON to activate the LED indicators and the BUZZER.
During normal operation this DIP MUST be set to OFF.

3.LED INDICATORS

RED LED	during the test it turns on simultaneously with the BUZZER when the sensor goes into alarm
BLUE LED	each time a new mode is set using the function selector, this flashes to indicate the selected program.

4.FUNCTION SELECTOR

4.1 STANDARD APPLICATIONS

1	Lightweight mesh panels
2	Rigid/Thick mesh panels
3	Non-welded chain link fencing
4	Rigid welded mesh fencing
5	Anti-intrusion walls/railings
6	Windows - Indoor

4.2 SELF-LEARNING

7	Self-learning for alarm
8	Self-learning for disqualification
9	Self-learning for spontaneous vibration

4.3 RESET

0	Reset
----------	-------



5.AJUSTMENT TRIMMER

It is possible to adjust the alarm sensitivity for each selected application

Increasing the sensitivity leads to a greater detection range and a shorter intervention time. It is advisable to adjust the sensitivity of the sensor to the minimum necessary in order to minimise unwanted detections.

It is recommended to increase sensitivity when the fence can be climbed quickly.

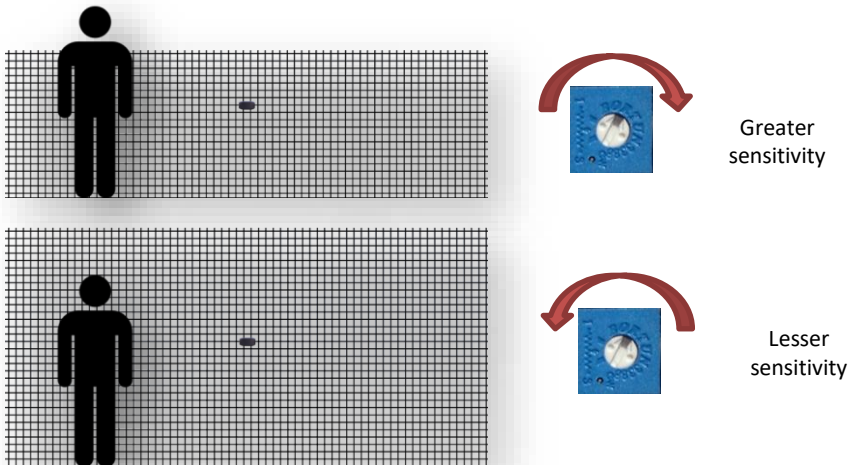

Fit the sensors evenly between them, keeping the maximum recommended distance, so that the vibrations that they may receive are the same for each.

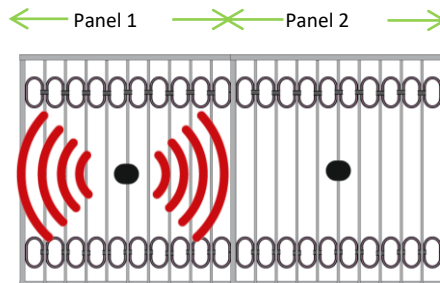

9. Description of the functions

Operating principles and applications

The system is designed for detection in the event of a breach, climbing over and cutting.

In the case of mounting on masonry, the system only detects an attempt at breaching.

In the case of mounting on mesh, cut detection occurs when a potential intruder cuts the mesh and tries to pass through it.

In the case of non-welded mesh mounting, it is necessary to use a panel sensor to have an efficient level of protection against cutting.

The system works properly only if the fencing is stable and uniform.

Standard applications

- **Lightweight mesh panels:** typical mounting in the centre of alternate panels, i.e. one yes, one no. If vibrations are propagated considerably, it is possible to mount one every three panels, i.e. one yes and two no.
- **Rigid mesh panels:** typical mounting in the centre of alternate panels, i.e. one yes, one no. If vibrations are not propagated very much, mount a sensor on each panel.
- **Non-welded chain link fencing:** typical mounting near the anchoring post, mounting of a sensor on each section for cutting detection.
- **Rigid welded mesh fencing:** typical mounting in the centre of alternate panels, i.e. one yes, one no. If vibrations are propagated considerably, it is possible to mount one every three panels, i.e. one yes and two no.
- **Anti-intrusion wall:** depending on the structure of the wall, typically mount a sensor every 5m.
- **Windows or internal applications:** mount a sensor every 5m depending on the structure.

The Gapid sensor has been designed to read all types of VIBRATION and movement on the AXES. It can be fitted on any type of structure that generates vibrations, not only those listed here.

The alarm is generated after successive vibrations depending on the calibration and sensitivity set in the sensor.

It can generate an alarm even if the sensor is tilted more than 25° from its original axis.

Unconventional application examples:- scaffolding

- lightwells
- overhead doors
- balconies with wire mesh panelling
- manholes
- automatic vending machines



9.1 Lightweight mesh panels

With this programming, attempts made to climb, break through and cut metal fencing up to 5mm thick are detected.

With maximum sensitivity, a range of action of about 2.5 m is reached

N.B.: the sensitivity may vary according to the type of mesh/fencing and the anchoring to the ground.



9.2 Rigid mesh panels

With this programming, attempts to climb, break through and cut metal fencing above 5mm thick are detected.

With maximum sensitivity, a range of action of about 2.5 m is reached

N.B.: the sensitivity may vary according to the type of mesh/fencing and the anchoring to the ground.



9.3 Non-welded chain link fencing

With this programming, attempts made to climb over, break through and cut metal mesh are detected

With maximum sensitivity, a range of action of about 2.5 m is reached

WARNING: If the mesh proves to be poorly anchored or extremely weak, position the sensor near the support post.

N.B.: the sensitivity may vary according to the type of mesh/fencing and the anchoring to the ground.

N.B.: avoid the application of sheeting/tarpaulins on this type of mesh which can create a "sail effect" causing possible false alarms in case of strong wind.



9.4 Rigid/welded mesh fencing

With this programming, attempts made to climb over, break through and cut metal mesh **well anchored to the ground are detected**.

With maximum sensitivity, a range of action of about 2.5 m is reached

N.B.: the sensitivity may vary according to the type of mesh/fencing and the anchoring to the ground.



9.5 Anti-intrusion walls/railings

With this programming, attempts to break through walls and cut railings are detected

With maximum sensitivity, a range of action of about 2.5 m is reached

N.B.: the sensitivity may vary according to the type and thickness of the wall/railings.



9.6 Windows and indoor applications

With this programming, attempts to break through windows and related frames/fixtures are detected.

This function is the most sensitive and is typically used for INDOOR applications.

With maximum sensitivity, a range of action of about 2.5 m is reached

N.B.: sensitivity may vary according to the type and thickness of the glass.



9.7 Self-learning for alarm

It is possible to make the sensor acquire an additional signal in addition to the standard ones. An alarm signal is sent whenever a signal similar in intensity and duration to that recorded during the calibration phase is detected by the system.

With low sensitivity, the detected signal must be identical to that recorded in order for the sensor to go into alarm, whereas with high sensitivity, the detected signal may differ slightly from that recorded.

N.B.:Use these functions ONLY for particular applications with constant and repetitive vibrations

9.8 Self-learning for disqualification

It is possible to make the sensor acquire an additional signal in addition to the standard ones. Whenever a signal similar in intensity and duration to that recorded during the calibration phase is perceived, the system will inhibit the alarm for the duration of this signal.

With high sensitivity, the signal detected must be identical to that recorded in order for the sensor to perform disqualification; whereas, with low sensitivity, the signal detected may differ slightly from that recorded.

N.B.:Use these functions ONLY for particular applications with constant and repetitive vibrations

9.9 Self-learning for spontaneous vibration

It is possible for the sensor to acquire spontaneous (natural) movement/vibration of the fence. Wire mesh panels and fencing in particular can move due to natural effects such as wind and rain.

Such movements do NOT occur during attempts to climb, cut or similar intrusions.

Therefore, it is possible for Gapid to learn the resonance of the fencing. It will then be filtered in order to cancel any false alarms due to such type of movement.

9.10 Reset

All the signals recorded during the self-learning functions are reset. The LED indicator lights up to confirm that the operation has been carried out.



10. Calibration

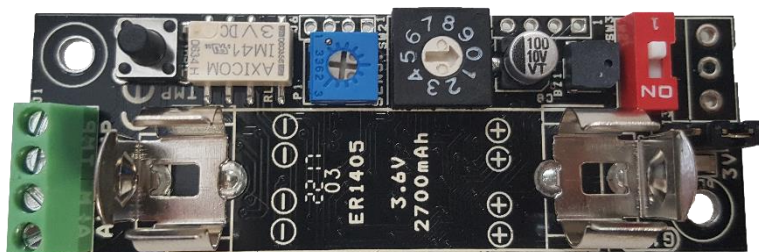

1. Set the DIP to ON so as to activate the calibration phase.
2. Select the standard function according to the application. The BLUE LED will indicate the selected program followed by a confirmation BEEP from the buzzer.
3. Adjust the sensitivity using the dedicated trimmer by carrying out tests. Whenever the sensor goes into alarm, the event is signalled with the lighting up of the RED LED and the buzzer. 20 seconds must pass between one alarm and the next. It is advisable to adjust the sensitivity of the sensor to the minimum necessary in order to minimise unwanted detections.
4. Position the DIP on 1 to exit the calibration phase.

10.1 Calibration with self-learning functions

Use these functions only if you want to acquire particular signals other than the standard ones.

ALL THREE FUNCTIONS CAN BE USED SIMULTANEOUSLY

10.2 Self-learning function for alarm

- a) Place the DIP in ON.
- b) Select function number 7 and wait for confirmation from the BLUE LED and buzzer.
- c) Carry out the disturbance to be recorded. Once this disturbance has started, the RED LED will light up and go off as soon as this disturbance has ended and a double beep will be given to confirm acquisition. If the RED LED does not light up, it means that the disturbance is too gentle to be acquired.
- d) Reselect the standard function.
- e) Place the DIP on 1.

It is advisable to carry out a disturbance for no longer than 10 seconds.



10.3 Self-learning function for disqualification

- a) Place the DIP in ON.
- b) Select function number 8 and wait for confirmation from the BLUE LED and buzzer.
- c) Carry out the disturbance to be recorded. Once this disturbance has started, the RED LED will light up and go off as soon as this disturbance has ended and a double beep will be given to confirm acquisition. If the RED LED does not light up, it means that the disturbance is too gentle to be acquired.
- d) Reselect the standard function.
- e) Place the DIP on 1.

It is advisable to carry out a disturbance for no longer than 10 seconds.

10.4 Self-learning function for spontaneous vibration

- a) Place the DIP in ON.
- b) Select function number 9 and wait for confirmation from the BLUE LED and BUZZER.
- c) Carry out the disturbance to be recorded, for example by hitting the fence to cause oscillation/movement. Once the main movement has been detected, the RED LED will light up and a double BEEP will be given to confirm the acquisition. If the RED LED does not light up, it means that the disturbance is too gentle to be acquired.
- d) Carry out the disturbance again. It is necessary to have two consecutive recordings to confirm the acquisition. If after a few attempts two successful detections are not obtained, it means that the fence has different oscillation frequencies and it is not possible to use this function.
- e) Reselect the standard function.
- f) Place the DIP on 1.

11. Technical specifications

MAXIMUM COVERAGE AREA	a diameter of 5 m
CALIBRATION AND PROGRAMMING OF THE SENSOR DIRECTLY ON BOARD	
3 SELF-LEARNING FUNCTIONS	
6 STANDARD APPLICATION FUNCTIONS	
POWER SUPPLY	3.6V battery
AUTONOMY	3 years with 3.6V 2.7Ah battery
CONSUMPTION	0.05 mA at rest/0.8 mA in alarm
OUTPUTS	Alarm (NC) Cover removal anti-tamper (NC) Low battery (negative open collector)
DIMENSIONS (WxHxD)	124 X 76 X 19 mm TX radio compartment max. 100 X 31 X 24 mm
MATERIAL	Scratch-resistant, UV-resistant black polycarbonate
INGRESS PROTECTION RATING	IP 66
OPERATING TEMPERATURE	-40°C +80°C
MOUNTING KIT INCLUDED WITH SCREWS AND METAL PLATE	
2-YEAR WARRANTY	



12.Product disposal

All components of the product are an integral part of the equipment and must be disposed of together with it.

Just as with installation operations, also at the end of life of these products, the dismantling operations must be carried out by qualified personnel.

These products are made up of various types of materials: some can be recycled and others must be disposed of. Find out about available recycling or disposal systems for this category of products governed by regulations in force in your area.

Warning!- Some parts of the products may contain polluting or dangerous substances which, if dispersed in the environment, could result in harmful effects on the environment itself and on human health.

As indicated by the symbol on the side, it is forbidden to throw these products in domestic waste.

Therefore, carry out "separate collection" for disposal, according to the methods stipulated by the regulations in force in your area or return the products to the seller when purchasing a new equivalent product.

Warning!- Local regulations can impose heavy penalties for incorrect disposal of these products.



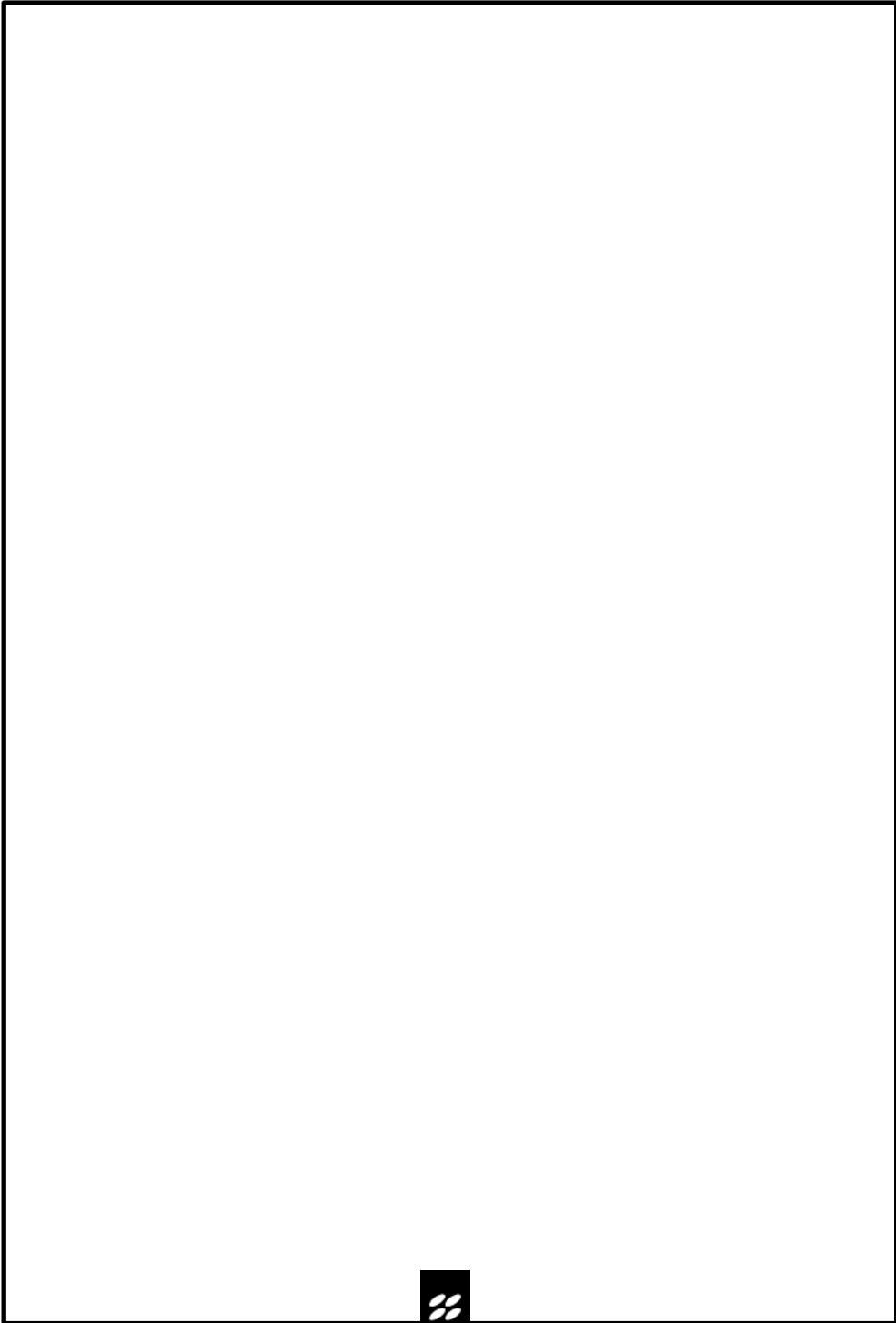



For technical support, contact your security
systems distributor