



PRODUCT
ALES

Product code ALES 60
ALES 120

ALES



DOUBLE OPTIC PERIMETER BARRIER

INSTALLATION AND MOUNTING MANUAL VERSION 2.1

Table of contents

1. Introduction.....	3
2. Product description.....	3
3. General warnings.....	4
3.1 Additional warnings for devices powered by mains voltage	
3.2 Installation warnings	
4. List of main components	5
5. Preparation for installation	6
5.1 Preparation of the barrier parts before installation	
5.2 It is advisable to carry out	
6. Examples of assembly/fixing	7
6.1 Placement and installation height	
7. Evaluations before installation.....	9
7.1 Introduction to barriers	
8. Barrier positioning.....	10
8.1 Precautions before installation	
9. Wiring.....	11
9.1 Type of cable	
10. Connections to the terminal board.....	12
11. Barrier alignment	13
11.1 Calibration using SMA system	
11.2 Alignment test	
12. Frequency selection	16
13. Intervention time adjustment	17
14. Technical specifications	17
15. FAQ	18
16. Product disposal	19



1. Introduction

Congratulations on having purchased the Politec perimeter barrier. This appliance guarantees long-lasting and reliable operation if installed correctly. For correct and effective use, it is necessary to read this instruction manual carefully.



The system has been designed to detect intrusions and activate the alarm; it is not a device that prevents intrusion. Politec is not responsible for damage, injury or loss caused by accidents, theft, force majeure (including momentary lightning-induced overcurrent), abuse, improper or incorrect use, faulty installation or inadequate maintenance.

2. Product description

The double optic infrared perimeter barrier consists of an infrared receiver and transmitter. Operation is based on the "AND" logical operations: in other words, the alarm is activated only in the event of simultaneous interruption of two superimposed beams.

This barrier is ideal for perimeter protection of internal and external areas.

It is equipped with a system for selecting the operating frequency that allows you to install multiple barriers on the same site without them interfering with each other. The main features of this barrier are:

- Adjustable intervention time which allows you to adapt to the characteristics of the site to be protected;
- Protection beam angle adjustment both vertically and horizontally;
- Set up for mounting on a wall, on a pole and on aluminium columns;
- Optical alignment with viewfinder and signal measurement points;
- Selection of the operating frequency on 4 channels to avoid interference with other barriers;
- Contact signalling barrier opening.



Warnings

Mounting, installation of the barrier and connection to the mains must be carried out by expert and qualified personnel, in compliance with rules and regulations applicable to electrical systems.

3.General warnings

This installation manual contains important information regarding safety for installation: it is necessary to read all the instructions before proceeding with the installation.

Keep this manual for future use.

- If you have any questions or doubts during installation, do not carry out any operations and contact the support service.
- Use of these products for purposes other than those specified in these instructions is prohibited.
- You must not make any changes to the components of the product unless stated in the manual in order not to void the warranty; such operations can only lead to malfunctions; Politec assumes no liability for malfunctions or damage due to modified products.
- Depending on the specific situation of use, check for the need for additional devices: detectors or signalling devices.
- During installation, mounting and use of the product, make sure no foreign objects (solids, metals or liquids) are able to penetrate inside the open devices.
- Manufacturer's liability:Politec assumes no liability for failures resulting from incorrect installation; lack of maintenance, incorrect assembly or use.
- Politec is also not liable for incorrect or incomplete operation of the product or failure to detect intrusion.
- Warranty (summary of conditions):Politec guarantees its products for a period of 2 years from the production date.The warranty is applied to those purchasing directly from Politec; there is no warranty for the end user who, in the event of breakdowns or faults, must contact the installer or dealer.
- The warranty excludes aesthetic parts as well as parts subject to normal wear and parts subject to normal consumption such as batteries and accumulators.

3.1 Additional warnings for devices powered by mains voltage

This manual is intended only for technical personnel qualified to install such devices.

- Assessing the hazards that may occur during installation and use of the system, in order to achieve complete safety, it is necessary that installation takes place in full compliance with applicable laws, methods, rules and regulations.
- Before accessing the internal terminals of the product, it is necessary to disconnect all the power circuits.
- If automatic circuit breakers or fuses trip, before resetting them it is necessary to identify the fault and repair it.

3.2 Installation warnings

- Check that all the material to be used is in excellent condition and suitable for use.
- Before proceeding with the installation, check the environmental class of the products in the "technical specifications" chapter.
- Check, by comparing with the values shown in the paragraph "technical specifications", that the range of the devices is equal to or lower than the physical distance between the barriers.
- Check that the barrier is positioned in areas protected against potential impact, in flat areas and on fixed supports to avoid oscillations.
- Do not place the system components close to heat sources as they could be damaged.
- Each barrier has its own operating principle: check the instructions for choosing the right position in the respective instruction manual.



4. List of main components

The package contains the following components and accessories.
When opening the package, check that everything has been included.

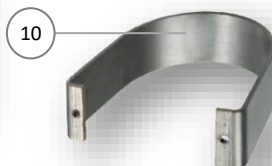

No	COMPONENT
1	Polycarbonate black cover
2	Terminal board
3	Trimmer
4	Channel selector and functions
5	Cover opening tamper
6	Horizontal adjustment lock screw
7	Vertical adjustment screw
8	High intensity alignment LEDs only on (RX)
9	Alignment buzzer only on (RX)
10	U-shaped bracket for pole fixing
11	Wall fixing plate

5. Preparation for installation

5.1 Preparation of the barrier parts before installation

Since the communication between the barriers can take place wired, via wireless and their alignment can be done optically, it is advisable to firstly check all the component parts of the barriers and any accessories before beginning the installation.

5.2 It is advisable to carry out:

- device configuration on a table;
- a check on the operation of the optical and acoustic alignment
- the permanent fixing of each device;
- the preparation and carrying out of electrical connections.

In order to avoid errors, operating and installation problems, it is advisable to proceed as follows:

- a) Place all the products with the package open on a table;
- b) For the low consumption barrier version for wireless models with universal electronic board housing, insert and connect the radio transmitter, and connect it to the barrier receiver board
- c) Power up the barriers and program them
- d) Test barrier operation;
- e) Place (without fixing) the barriers at the planned points;
- f) Place (without fixing) all the other devices at the planned points;
- g) Check for each barrier that there is sufficient field for radio communication (for wireless versions);
- h) Permanently fix the barriers.

Before proceeding with the installation, it is necessary to check the integrity of the product, the adequacy of the model chosen and the suitability of the environment intended for installation:

- Check that all conditions of use fall within the "limits of use" and in the "Technical specifications of the product".
- Check that the environment chosen for the installation is compatible with the total footprint of the product.
- Check that the surface chosen for the installation of the product is sturdy so as to ensure stable fixing and that it is adequately protected against possible impacts or the elements.



6.Examples of assembly/fixing

6.1 Placement and installation height

Position the barrier considering the type of surrounding environment and the protection distance for correct and effective operation.Position it in such a way that there are no obstacles in its range of action (trees/plants or objects that can swing or move with the wind or rain).

Position the barrier so that sunlight does not hit it directly near the sensors.

However, it is necessary to take into consideration the specific beam diffusion of each model so as to avoid reflection of the rays caused by the ground or by adjacent objects.

The ALES barrier can be installed on a wall, using the fixing plate, or on a pole, adding the U-shaped bracket (Ø 48-50 mm pole).

- Remove the cover by unscrewing the screw located on the front
- Loosen the plate locking screw and remove it by sliding it down against the base.

Wall mounting

- Pass the connection cable through the hole in the fixing plate and fix the plate to the wall with the screws
- Make the connections on the terminal board
- After checking the alignment and correct operation, refit the cover and tighten the closing screw firmly.

Pole mounting

The supplied brackets allow mounting on poles with a diameter of 48 - 50 mm

- Drill an 8mm diameter hole on the pole for the passage of the connection cable
- Pass the connection cable through the hole and through the opening in the fixing plate
- Place the U-shaped brackets on the pole and fix them to the plate with the screws provided
- Make the connections on the terminal board
- After checking the alignment and correct operation, refit the cover and tighten the closing screw firmly.

WARNING:

Product warranty is invalid if there is any hole in the aluminium profile or any component



6.2 Placement and installation height

In order to correctly install the product, it is necessary to remove all possible obstacles in the section between the transmitter and receiver column (trees, grass, etc.), using irremovable walls or poles firmly anchored to the ground for installation.

Shielded alarm cables must always be used for connections with the correct sizing (\varnothing 0.22 for short distances, \varnothing 0.5 for large distances), always taking the necessary precautions required for electronic devices.

In order not to alter the performance and the degree of protection (IP) of the barrier, it is necessary to take the necessary precautions. You must be careful not to alter the seals, plastics and mechanical parts of the product, and use the original accessories.

In the case of repairs under warranty (2 years) but with evident signs of incorrect installation, Politec s.r.l. shall reserve the right to decide on any repair costs.

N.B.: Avoid installing the receiver in a position where the sun's rays can directly affect the optics.

Wall mounting

- Insert the alarm cable with shield in the hole of the plate and fix to the wall with the screws
- Pass the cable inside the gasket located in the base unit and anchor it on the fixing plate. Make connections to the terminal board.
- After calibration and verification of correct operation, refit the cover.

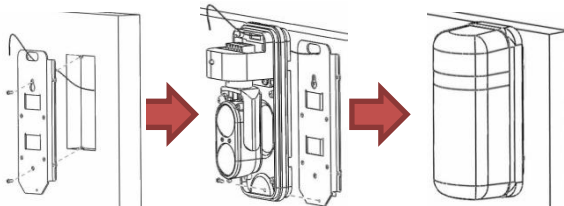

Pole mounting

- Insert the alarm cable with shield into the hole in the plate and fix the plate to the pole using the U-shaped bracket.
- Pass the cable inside the gasket located in the base unit and anchor it on the fixing plate. Make connections to the terminal board.
- After calibration and verification of correct operation, refit the cover.

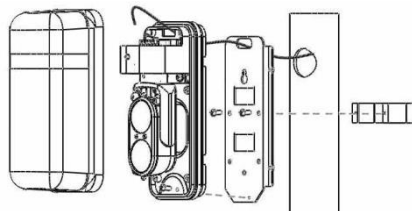

WARNING:

Product warranty is invalid if there is any hole in the aluminium profile or any component



7. Evaluations before installation

7.1 Introduction to barriers

The Active Infrared Barrier is characterised by two components, a TX transmitter that impulsively emits an infrared signal towards the RX receiver. This signal is constantly controlled by a **CODED SYNCHRONISM** which can be **WIRED or OPTICAL** according to the different types of barriers.

The transmitted infrared beam takes on a conical shape: the greater the distance between TX and RX, the greater the diameter of the cone when it arrives.

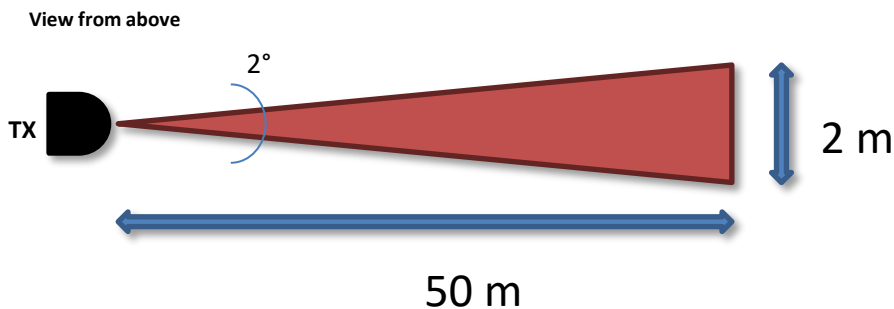

Signal interruption:ALARM

A barrier can be composed of several TX transmitters and RX receivers mounted inside specific different columns.

The infrared barriers have multiple controls that significantly limit false alarms, as the genuine alarm signal is given by the complete interruption of the infrared signal.

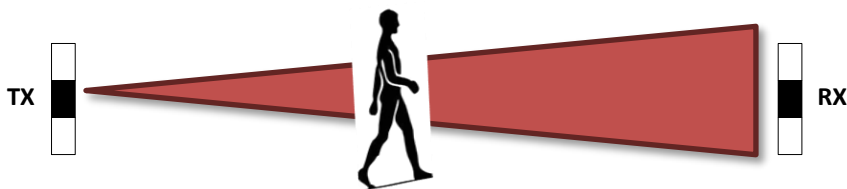

POWER SUPPLY

The barriers can be divided into two categories, powered at low voltage and connected by wire, or powered by batteries for Wireless systems, then combined with radio transmitters to communicate with the alarm control unit, as required by specific sector regulations.

HEATERS

It is recommended to power the thermostating system as, in conditions of high humidity, the condensation that is created on the screen can lead to a significant decrease in the IR signal up to the alarm. For obvious reasons, for battery powered barriers, there is no thermostat control even if set up for it, therefore to minimise problems, it is necessary to reduce the working distance between TX and RX, thus ensuring a good amount of signal constantly, even in case of particular climatic conditions.

N.B. The ALES TS thermostat control kit is an optional accessory.

8. Positioning barriers

8.1 Precautions before installation

In order to avoid false alarms, it is advisable to place the barriers away from reflecting surfaces, away from walls or anything that can attenuate the signal.

DO NOT place the barriers if there are plants, bushes or fixed objects in the range that obstruct the signal and create "grey areas". Leave a corridor of 50cm for distances between columns greater than 50m

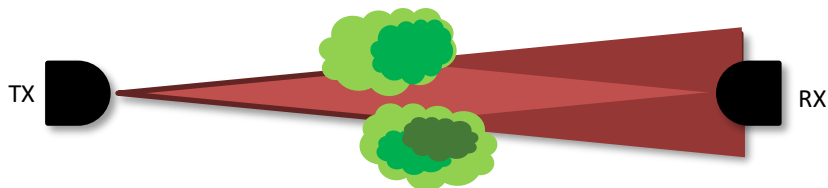

DO NOT place the barriers close to walls, without spacing the columns with adequate brackets, as the signal quality may decrease

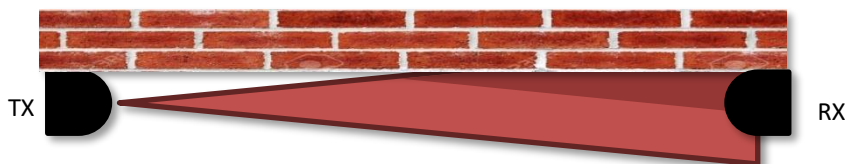

DO NOT place barriers close to roads: vehicle lights directed towards the RX could create disturbances

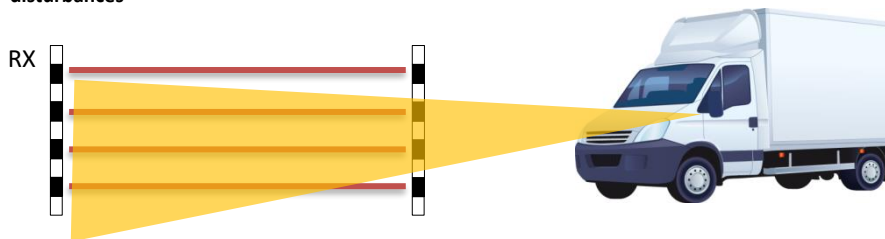

DO NOT place barriers near automatic gates: photocell signals can create interference

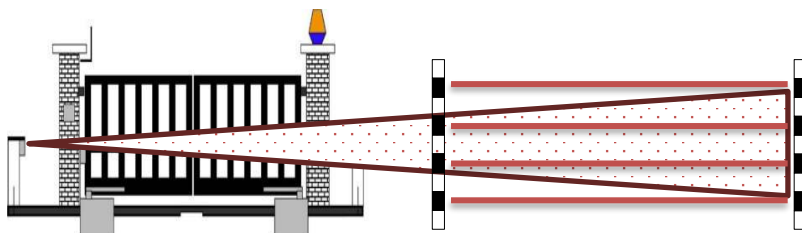

9. Wiring

9.1 Type of cable

Wiring requires you to **SEPARATE** the SHIELDED cable of the 12Vdc power supply plus all the signals to the control unit (e.g. 2x0.5 + Nx0.22), from the power cable of the 12/24Vdc heaters (ALES TS optional extras) (e.g. 2x0.75) to avoid voltage drops on the barrier.

N.B. it is absolutely necessary to shield the cable that supplies the 12 Vdc power supply and to ground the metal braid.



The sizing of the cables depends on the consumption of the columns and on the resistance of the cable itself according to the distances involved.

The table shows the cable cross-sections and the relative distances to ensure optimum performance using the LAR22 power supply (12Vdc-2.5A/24Vac-300W) and an ALES barrier.

CONDUCTOR CROSS-SECTION	POWER SUPPLY BOARDS 12Vdc
0.5 mm ²	165 m
0.75 mm ²	245 m
1.5 mm ²	490 m
2.5 mm ²	820 m

N.B.The LAR22 container is metallic, so it must be placed inside a room or inserted in a watertight container if used outdoors. A battery up to 18Ah can be housed in the container.

N.B.Since a voltage of 12/24Vdc is required with rather significant consumption, it is recommended to power the thermostating system from a source even without buffer batteries but different from the power supply for the electronic part of the barrier, normally equipped with buffer batteries to ensure operation in the absence of mains supply.



10.Connections to the terminal board

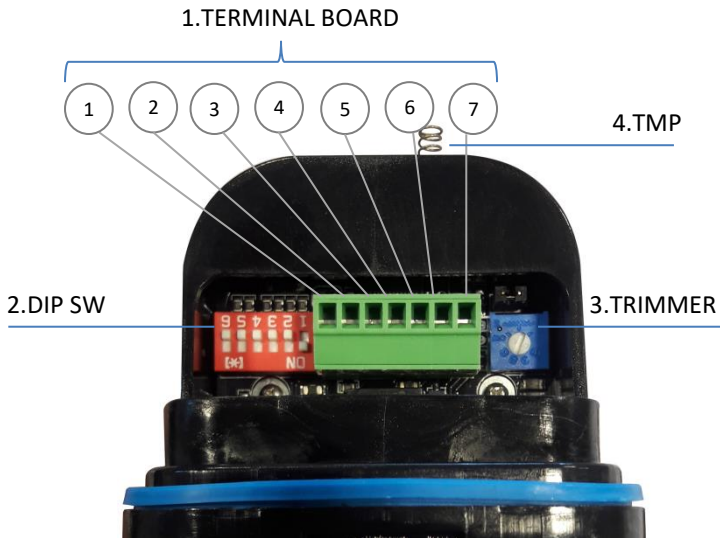

1	TERMINAL BOARD	1	Power supply 12 - 30 Vdc
		2	
		3	NC Tamper contact
		4	
		5	NC Alarm contact (only on RX)
		6	
		7	Fog disqualification output (only on RX) O.C.:NO to GND
2	DIP SW	1. Channel 1 2. Channel 2 3. Channel 3 4. Channel 4 5. Fog disqualification (only on RX board) 6. SMA test (only on RX board)	
3	TRIMMER	To adjust the intervention time (only on RX)	
4	TMP	Spring-loaded TAMPER to protect against cover removal	



11.Barrier alignment

For correct alignment, once the barriers are installed, orient the optical units of the transmitters and the optical units of the receivers towards each other, adjusting the lens holder horizontally manually, after having loosened the locking screw on the joint and vertically through the front screw located to the left of the lens.

Vertical orientation

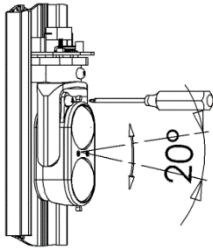

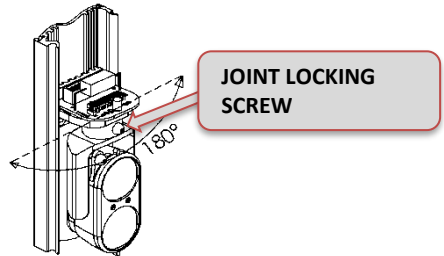

Horizontal orientation



N.B.:Tighten the joint locking screw after making the adjustment

11.1 Calibration using SMA system

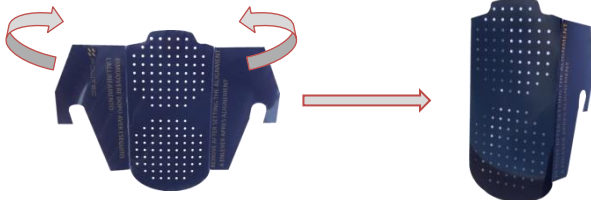
It is possible to improve the calibration by using the supplied filter.

1. Fold the device following the pre-set folds

2. Position the filter in front of the TX optic positioning the two hooks on the pins of the optic fork. The filter is designed to refine the search for the alignment signal under critical conditions.

It is sufficient to apply the filter only on the TX, there is no need to repeat the operation also on the RX.



11.2 Alignment test

- Power the unit electrically
- Set the parameters relating to the various functions
- Set to ON DIP 6 on the RX optics board
- The high intensity LEDs and the BUZZER on the RX optic are activated



- Orient the TX optic on the column towards the RX optic, vertically and horizontally acting as explained above, until you find the maximum alignment.

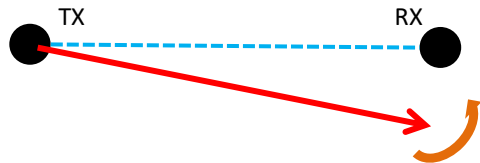

- The maximum alignment condition will be reached when the high intensity LEDs are on steady and the buzzer will emit a continuous sound, for this reason, it may be necessary to make minor adjustments also on the RX optic.



N.B.: the fixed buzzer sound has a maximum duration of 3 minutes. To obtain a good alignment it is necessary to complete a FULL rotation on the horizontal axis of the RECEIVER optic, thereby performing the SCANNING of the optical signal.

- The partial or total misalignment condition is signalled by the infrequent flashing of the LEDs and by the non-continuous whistle of the buzzer.
- After calibration, tighten the horizontal adjustment screw and exit the test function by returning DIP 6 to OFF on the RX board, activating the automatic WALK TEST phase for 60 seconds.

At the end of the operation, remove the screen which acts as an attenuator, making sure to have found the optimal value.

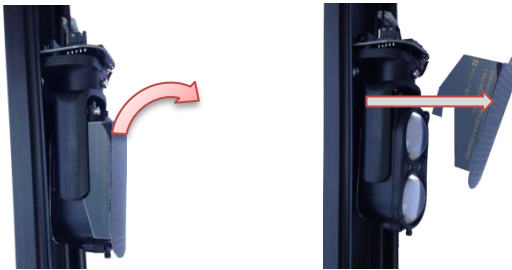

N.B.: Optical synchronism requires greater attention during the installation phases, in particular, that the receiving column is not affected by other sources of IR light.

To be absolutely certain that the alignment of the optics is correct (and therefore no false alignments due to the transmission of other infrared sources, such as other barriers of the same system as well as gate photocells) cover the TRANSMITTER optic with your hand: if the RECEIVER continues to give a continuous beep, it means that it sees another infrared source that must be turned off and eliminated.



12.Frequency selection

To set up barriers with more than one pair of ALES, in order to avoid interference, you must assign a different channel to each of them. To do this, set the DIP SWITCH of the desired channel to ON.

The channel must be the same on both the transmitter and receiver sides

(e.g. CH_TX1→CH_RX1 – CH_TX2→CH_RX2 – CH_TX3→CH_RX3 – CH_TX4→CH_RX4).

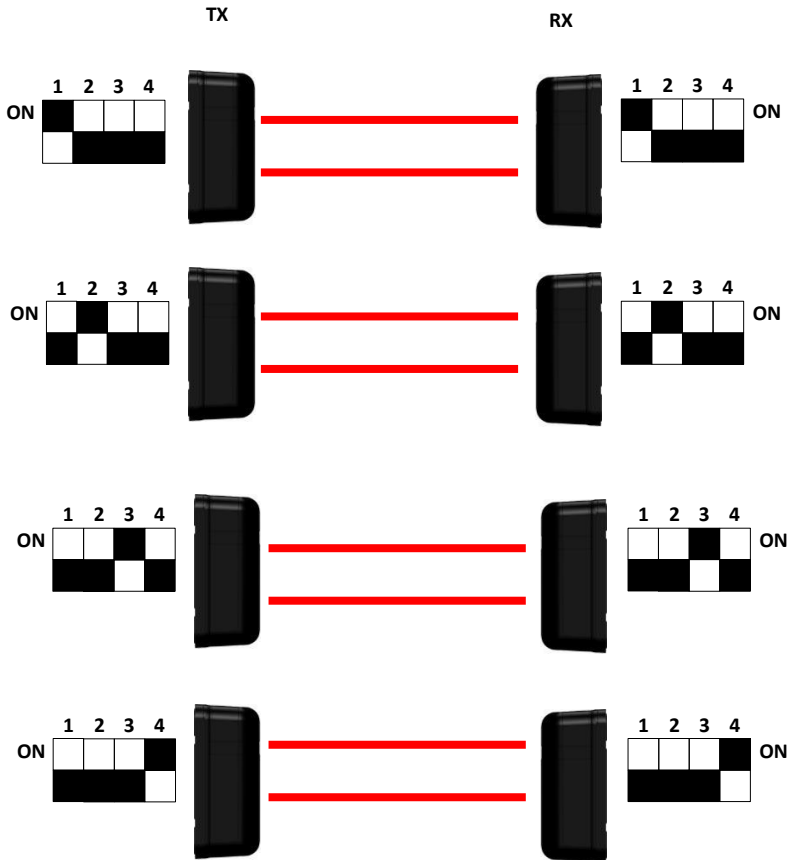

13. Intervention time adjustment

On the RX board there is a potentiometer to adjust the INTERVENTION TIME.

In particular, it is possible to set the barrier for rapid (crossing while running) or slow (crossing while walking) alarms.

By adjusting the potentiometer anticlockwise, the intervention time is increased up to 500ms. In this condition, the alarm of a person crossing the barrier while walking is guaranteed, with the advantage of excluding the possibility of any false alarms (e.g. animal crossing).

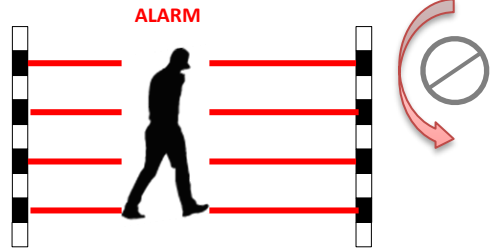

By adjusting the potentiometer clockwise, the intervention time decreases down to 50ms. In this condition, the alarm of a person crossing the barrier running at maximum speed is guaranteed.

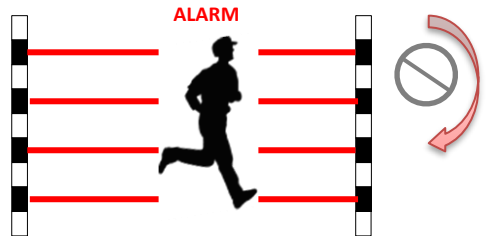

14. Technical specifications

	ALES 60 120
Outdoor range	1-60 m / 1-120 m
Indoor range	1-250 m / 1-480 m
Synchronism	4-channel optic
Disqualification from fog	Yes, with open collector output
Intervention time adjustment	From 50 to 500 ms
Power supply	12-30Vdc
Consumption	90mA per pair
Heater	Optional with 10-30Vdc thermostat : 10/15Vdc = 6W, 0.8 A per pair 20/30Vdc = 6W, 0.4 A per pair
Alarm and Tamper outputs	NC Contacts
Operating temperature	-25° (with heating)+65°
Ingress protection rating	IP65
Pole/wall mounting accessories	
2-YEAR FULL WARRANTY	



15.FAQ

I can't align	<ul style="list-style-type: none">• Check that there are no obstacles of any kind interposed between RX and TX and that the conditions of the site do not represent an impediment;• Check that the power supply on the terminal board is sufficient;• Use the shielded cable for the power supply by connecting the braiding to the earth (in case of persistent problem, it is recommended to connect the alarm and power supply/tamper with two separate shielded cables);• Check the correct sizing of the power cables;• Make sure there are no external light sources that interfere with the correct reading of the signal (gate photocells, other barriers, infrared etc.);• It is possible to increase the shielding by connecting the ground of the terminal board with the screw located under the optics that fixes the plastic base to the metal fixing plate;
After accurately aligning the sensor (LED light on steady and continuous BEEP) the system remains in alarm	<ul style="list-style-type: none">• Make sure RX and TX have the same channel;• Make sure there are no external light sources that interfere with the correct reading of the signal (gate photocells, other barriers, infrared etc.);• Use the shielded cable for the power supply by connecting the braiding to the earth (in case of persistent problem, it is recommended to connect the alarm/tamper and power supply with two separate shielded cables);• Check the correct sizing of the power cables;• It is possible to increase the shielding by connecting the ground of the terminal board with the screw located under the optics that fixes the plastic base to the metal fixing plate;
The system goes into alarm with fog and rain	<ul style="list-style-type: none">• Make sure that the fog disqualification function is active;• Make sure that the structure is well sealed and check that there are not already disturbing elements inside (water, insects etc.);• Check alignment is accurate and, if necessary, carry out the procedure by performing a complete scan, making sure that there are no light sources that can influence the calibration;• For more precise alignment, position one side of the Ales cover in front of the lenses in order to have two surfaces interposed between TX and RX to double the attenuation of the beam;• For long distances it is recommended to use the additional external thermostat ensuring sufficient power,



Repeated false alarms

- Use the shielded cable for the power supply by connecting the braiding to the earth (in case of persistent problem, it is recommended to connect the alarm/tamper and power supply with two separate shielded cables);
- Check the correct sizing of the power cables;
- It is possible to increase the shielding by connecting the ground of the terminal board with the screw located under the optics that fixes the plastic base to the metal fixing plate;
- If possible, increase the intervention time.

16.Product disposal.

All components of this barrier are an integral part of the equipment and must be disposed of together with it.

Just as with installation operations, also at the end of life of these products, the dismantling operations must be carried out by qualified personnel.

These products are made up of various types of materials: some can be recycled and others must be disposed of. Find out about available recycling or disposal systems for this category of products governed by regulations in force in your area.

Warning!- Some parts of the products may contain polluting or dangerous substances which, if dispersed in the environment, could result in harmful effects on the environment itself and on human health.

As indicated by the symbol on the side, it is forbidden to throw these products in domestic waste.

Therefore, carry out "separate collection" for disposal, according to the methods stipulated by the regulations in force in your area or return the products to the seller when purchasing a new equivalent product.

Warning!- Local regulations can impose heavy penalties for incorrect disposal of these products.





For technical support, contact your security
systems distributor